

Luna analytical balances are designed with an array of features and functions that accommodate most lab applications. The Luna range offers improved performance for faster, more accurate readings. With stylish, modern backlighting, Luna's impressive display gives an aura of smart sophistication. The LCD features large, readily discernible 24mm digits in white on a black background. Multilingual text and display capability make Luna well-suited for users in various regions. For simple operation, navigation buttons are colour-coded, helping users perform functions with minimal training. Luna provides USB and RS-232 interfaces to facilitate data collection and transmission to computers or printers. ABS plastic construction and rugged grade 304 stainless steel pan mean Luna is easy to clean and can withstand demanding lab use. Available in four models with capacities up to 250g, Luna offers a readability of 0.0001g and can perform basic and detailed measuring tasks.

Performance and style for an impressive weighing experience



Features

- Vivid, backlit LCD easily visible in any lighting conditions
- Colour-coded keys facilitate quick recognition of the most frequently used buttons
- Level indicator and adjustable feet ensure proper balance setup for optimum weighing results
- Security slot for optional Kensington-type lock and cable to help prevent theft
- Large, grade 304 stainless steel pan allows easy cleaning
- Sealed keypad protects against dirt and spills
- USB and RS-232 interfaces provide speedy communication with computers and printers
- External calibration allows for verification and adjustment with weights
- Multilingual display allows use in many different countries
- Parts counting with preset sample sizes
- Printouts include date and time for data tracking within Good Laboratory Practices (GLP) guidelines
- Selectable digital filtering for animal/dynamic weighing enables consistent results for moving subjects
- Auto power-off to save energy
- AC adapter included

Applications

- Weighing
- Parts counting
- Percentage weighing
- Dynamic / animal weighing
- Density determination
- Checkweighing
- Net total weighing

About ADAM:

For more than 45 years, professionals worldwide have relied on Adam Equipment for an extensive selection of dependable and affordable weighing equipment. Adam provides the right balance of speed, performance and value.

Product Details

Model	LAB 84e	LAB 124e	LAB 214e	LAB 254e	LAB 84i	LAB 124i	LAB 214i	LAB 254i
Capacity	80g	120g	210g	250g	80g	120g	210g	250g
Readability	0.0001g	0.0001g	0.0001g	0.0001g	0.0001g	0.0001g	0.0001g	0.0001g
Repeatability (S.D.)	0.0001g	0.0001g	0.0001g	0.0001g	0.0001g	0.0001g	0.0001g	0.0001g
Linearity (+/-)	0.0002g	0.0002g	0.0002g	0.0003g	0.0002g	0.0002g	0.0002g	0.0003g
Minimum Weight (USP, Typical)	0.01g	0.01g	0.01g	0.01g	0.01g	0.01g	0.01g	0.01g
Pan Size	80mm ø							
Weighing Units	mg, g, ct, GN, N, dr, oz, ozt, dwt, mm, tl.T, tl.H, tl.S, T, custom unit							
Stabilisation Time (sec)	2							
Interface	RS-232 / USB							
Calibration	External calibration				Internal automatic calibration / External calibration			
Display	Backlit LCD with 24mm high digits							
Power Supply	18VDC 50/60Hz 830mA adapter							
Operating Temperature	15° to 35°C							
Housing	ABS plastic							
Draught Shield	Chamber 192x195x230mm							
Overall Dim.	224x374x338mm							
Net Weight	5.8kg				6.2kg			

Accessories

Item number	Description
104008036	Anti-vibration table
3074010267	USB cable
3012014259	In-use cover
1120011156	ATP thermal printer
3014011014	RS-232 cable M-F
700100046	Kensington-type lock and cable
600002028	AdamDU Data Collection Program
700660290	Calibration certificate
1120014641	AIP impact printer
700100410	ABI-1 Ioniser
700100207	E2 1g to 200g calibration weight set
700100022	E2 100g calibration weight
700100023	E2 200g calibration weight
700100232	E2 50g calibration weight
700100026	E2 1mg - 200g calibration weight set

Key Accessories



AIP impact printer

Easy to use, the AIP high-speed dot matrix printer connects with any device containing an RS-232 or USB interface. Communication is smooth and fast, as the AIP automatically detects a scale's settings. AIP features durable ABS plastic construction and is simple to use, as it operates with just an on/off switch and a paper feed button.



ATP thermal printer

Easy-to-use features combined with quick set-up equals a truly versatile thermal printer. A single push-button feed key and three easy-to-read LED indicators make operation simple.

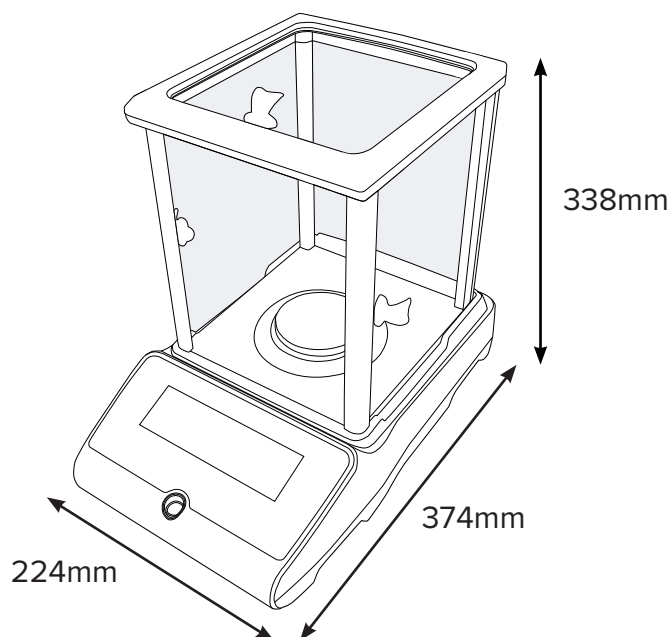

Supplied by

www.adamequipment.co.uk